

Article number: 20343650M1080KS

Description: E+G levelling foot
GN 343.6-50-M10-80-KS

Measures

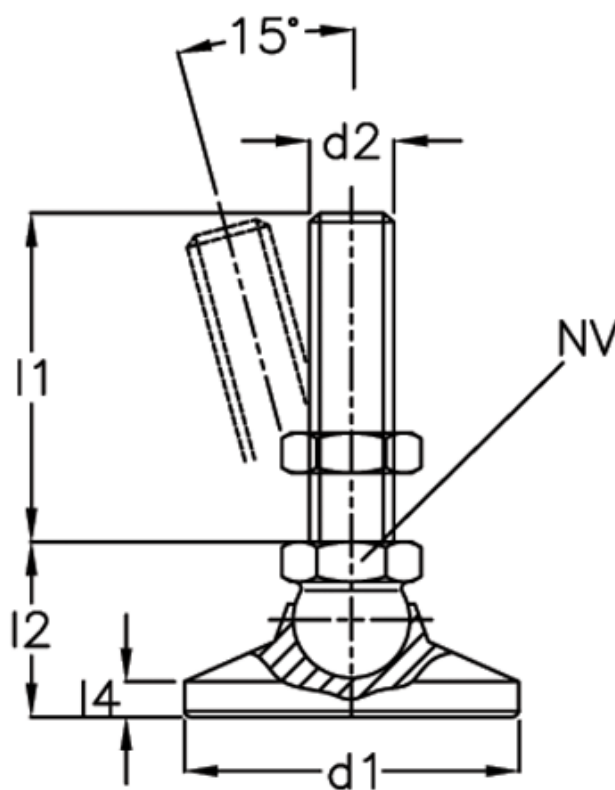

A/F	= 15
d1	= 50
d2	= 10
l1	= 80
l2	= -
l4	= -
Static load (N)	= 11
Weight in (g)	= 222